



SYNCHRO TAPPING HOLDER

Ø25

DIN 1835 B+E

Product code:
NGT ST1-25x32

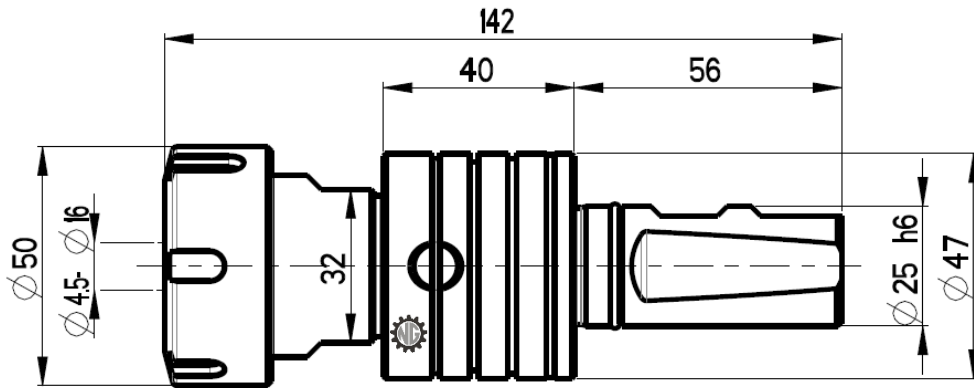

Collet: ER32

Cooling: internal

Max. pressure: 50 bar

Accessories

Nut : Hook spanner type E 32

Spindle: Spanner 32

