



SYNCHRO TAPPING HOLDER

Ø25

DIN 1835 B+E

Product code:
NGT ST2-25x20

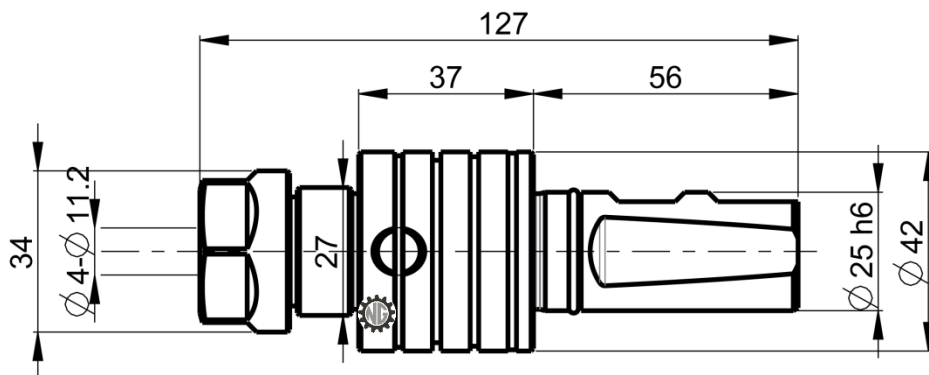

Collet: ER20

Cooling: internal

Max. pressure: 50 bar

Accessories

Nut : Hook spanner type E 20



Spindle: Spanner 27

