



# SYNCHRO TAPPING HOLDER

Ø32

DIN 1835 B+E

Product code:  
**NGT ST4-32x40**

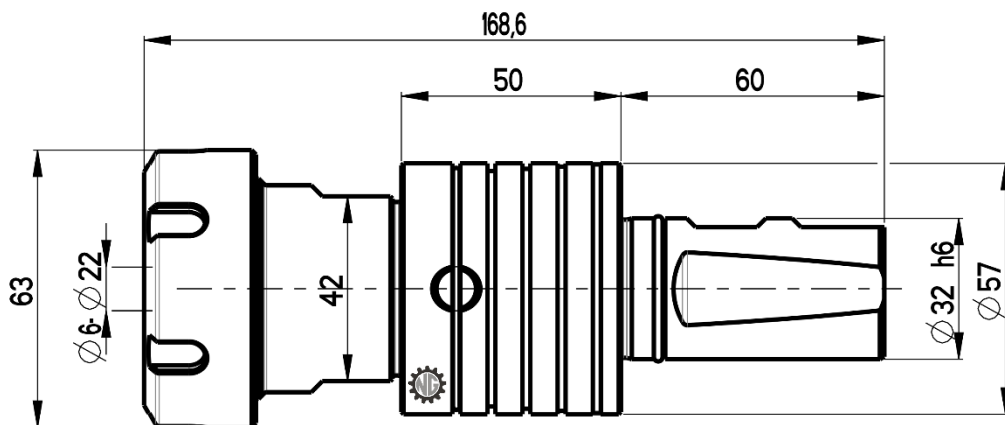

**Collet:** ER40

**Cooling:** internal

**Max. pressure:** 50 bar

## Accessories

**Nut :** Hook spanner type E 40

**Spindle:** Spanner 42

